

# POSITAL

FRABA

## TILTIX INCLINOMETER WITH ANALOG & RS232 INTERFACE

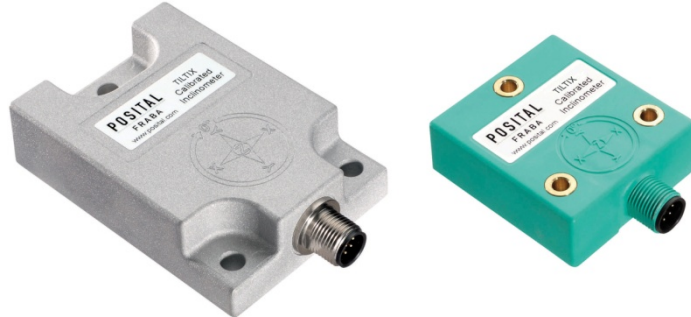

### User Manual

AMERICAS  
FRABA Inc.  
1800 East State Street, Suite 148  
Hamilton, NJ 08609-2020, USA  
T +1 609 750-8705, F +1 609 750-8703  
[www.posita.com](http://www.posita.com), [info@posita.com](mailto:info@posita.com)

EUROPE  
FRABA AG  
Carlswerkstrasse 13c  
51063 Köln, GERMANY  
T +49 221 96213-0, F +49 221 96213-20  
[www.posita.eu](http://www.posita.eu), [info@posita.eu](mailto:info@posita.eu)

ASIA  
FRABA Pte. Ltd.  
60 Alexandra Terrace,  
#02-05 The Comtech, SINGAPORE 118502  
T +65 6514 8880, F +65 6271 1792  
[www.posita.sg](http://www.posita.sg), [info@posita.sg](mailto:info@posita.sg)

# POSITAL

---

## FRABA

### TILTIX INCLINOMETER WITH ANALOG & RS232 INTERFACE

#### Table of Content

<b>General Safety Advice</b> .....	<b>3</b>	4.1.2 Wiring & Connection.....	10
<b>About This Manual</b> .....	<b>3</b>	4.1.3 Connection Setup.....	10
<b>1. Introduction</b> .....	<b>4</b>	4.2 Software Communication Setup.....	11
1.1 ACCELENS (ACS) .....	4	4.3 Table 1: Commands	
1.2 ACS Analog .....	4	in Configuration Mode .....	13
<b>2. Installation</b> .....	<b>5</b>	4.3.4 Table 2: Code Transmission Rates .....	15
2.1 Accessories .....	5	4.3.4 Table 3: Baud Rates .....	15
2.2 Pin Assignment .....	5	4.3.5 Preset/Direction and Teach-in Mode .....	16
2.3 Installation Precautions.....	6	<b>5. Analog Interface</b> .....	<b>18</b>
2.4 Measurement Axes .....	7	5.1.1 ACS – Voltage.....	18
<b>3. ACS-Analog Software Configuration</b> .....	<b>8</b>	5.1.2 ACS – Current .....	18
3.1 Default Factory Settings.....	8	5.3 Analog Inputs (SET1 and SET2) .....	19
3.2 Modes of Operation .....	8	5.3.1 Preset.....	19
3.3 Programmable Parameters .....	9	5.3.2 Invert Direction .....	20
<b>4. RS232 Digital Interface –</b>		5.3.3 Scaling of Output .....	20
<b>Setup and Programming</b> .....	<b>10</b>	<b>Appendix A: Ordering Code</b> .....	<b>21</b>
4.1 Hardware Setup .....	10	<b>Appendix B: ACS Output Data Frame</b> .....	<b>22</b>
4.1.1 Accessories Required .....	10	<b>Document History</b> .....	<b>23</b>

### TILTIX INCLINOMETER WITH ANALOG & RS232 INTERFACE

#### General Safety Advice

##### Important Information

Read these instructions carefully, and look at the equipment to become familiar with the device before trying to install, operate, or maintain it.

The following special messages may appear throughout this documentation or on the equipment to warn of potential hazards or to call attention towards information that clarifies/simplifies a procedure.



The addition of this symbol to a Danger or Warning safety label indicates that an electrical hazard exists, which will result in personal injury if the instructions are not followed.



This is the safety alert symbol. It is used to alert you to potential personal injury hazards. Obey all safety messages that follow this symbol to avoid possible injury or death.

##### Please Note

Electrical equipment should be serviced only by qualified trained personnel. No responsibility is assumed by POSITAL for any consequences arising out of the use of this material. This document is not intended as an instruction manual for untrained persons.

#### About this Manual

##### Background

This user manual explains how to install and configure the ACS inclinometer with an Analog (Voltage or Current) and RS232 interface.

##### Version Management

Updated on: 20120221

Document Name: Manual\_ACS\_Analog\_RS232.pdf

##### Copyright

The company POSITAL GmbH claims copyright on this documentation. It is not allowed to modify, to extend, to hand over to a third party and to copy this documentation without written approval by the company POSITAL GmbH. Nor is any liability assumed for damages resulting from the use of the information contained herein. Further, this publication and features described herein are subject to change without notice.

##### User Annotation

All readers are highly welcome to send us feedback and comments about this document. You can reach us by e-mail to your respective region.

### TILTIX INCLINOMETER WITH ANALOG & RS232 INTERFACE

#### 1. Introduction

This manual explains how to install and configure the ACS inclinometers (suitable for industrial, military and heavy duty applications) with an Analog + RS232 interface.

##### 1.1 ACCELENS (ACS)

ACS inclinometers sense and measure the angle of tilt (Inclination/Slope) of an object with respect to the force of gravity. The angle is measured with the relative change in electrical capacitance.

The basic principle behind the device is a Micro-Electro-Mechanical System (MEMS) sensor cell that is embedded to a fully molded ASIC. A simplified version of the sensor consists of two electrodes, one is fixed, and the other is flexible (connected with spring elements). When the inclinometer is parallel to the surface of measurement, a corresponding capacitance is measured. If the sensor is tilted, the flexible electrode will change its position relative to the fixed electrode. This results in a change of the capacitance between the two electrodes which is measured by the sensor cell. The change of the capacitance is converted to a corresponding inclination value.

The ACS series of inclinometers are available in two variants; a single axis measurement variant with a range of 0 - 360° and a dual axis measurement.

##### 1.2 ACS Analog

The ACS Analog inclinometer is a simple, compact and a very low cost inclination measurement device capable of measuring precise absolute position in both single and dual axes.

It is compatible to most analog measurement devices while also including a RS232 digital interface. This RS232 interface can be used either to read the corresponding position output or for configuring the ACS according to the need of the application.

The dual output feature increases the flexibility and compatibility to other digital devices too. Electrically, like all other ACS variants it consists of a highly integrated circuit in SMD technology, temperature compensation, active linearization and the only variation is the analog interface. Customized scaling of analog output is also possible.

It is protected against polarity inversion and over voltage peak protection. In addition to that, the fully molded plastic housing provides a high resistance to shock/ vibration and environmental protection of up to IP69K when used with appropriate connectors.

The ACS Analog comes with bootloaders for easy re-configuration. The setup and configuration guide for the bootloaders is available upon request.

### TILTIX INCLINOMETER WITH ANALOG & RS232 INTERFACE

## 2. Installation

### 2.1 Accessories

Article No	Article	Description
ACS360/080	Inclinometer	ACS series of Inclinometers
<a href="#">Download</a>	Datasheet <sup>1</sup>	ACS Datasheet, specifications and drawings
<a href="#">ACS Website</a>	User Manual <sup>1</sup>	Installation and Configuration User Manual
<a href="#">Download</a>	Leaflet <sup>1</sup>	Installation Leaflet
34500801	P8F-STK8.2	Female M12, 8pin A-coded connector with 2m PUR shielded
34500802	P8F-STK8.5	Female M12, 8pin A-coded connector with 5m PUR shielded

1) The documentation can also be downloaded from our website.

### 2.2 Pin Assignment

The inclinometer is connected via an 8 pin M12 A-coded round connector or cable exit. (Standard M12, Male side at sensor, Female at connector counterpart or connection cable).

Pin	Cable Exit	ACS-080	ACS-360
1	Red	VS Supply Voltage	VS Supply Voltage
2	Gray	RxD (RS232)	RxD (RS232)
3	Pink	TxD (RS232)	TxD (RS232)
4	Yellow	Ground	Ground
5	Green	X-axis Analog Output	Z -Axis Analog
6	Brown	Analog input <sup>1)</sup> Preset or SET1	Analog input <sup>1)</sup> Preset or SET1
7	Blue	Y-axis Analog Output	Unused - Do Not
8	White	Analog input <sup>1)</sup> Inverse Direction or SET2 (Teach-In)	Analog input <sup>1)</sup> Inverse Direction or SET2 (Teach-In)

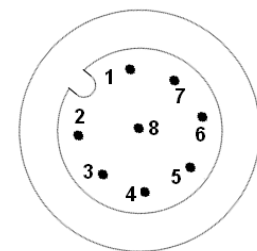

M12 Connector Pin  
Assignment

1) The function of the analog inputs depends on the configuration

## TILTIX INCLINOMETER WITH ANALOG & RS232 INTERFACE

### 2.3 Installation Precautions



#### WARNING

Do not remove or mount while the inclinometer is under power!



Avert any modifications to the plastic molding!

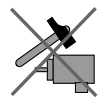

Avoid mechanical load!

Prior to installation, please check for all connections and mounting instructions to be complied with. Please also observe the general rules and regulations on operating low voltage technical devices, for safety and sustainability of ACS Inclinometers over long period of time.

(Please read the installation leaflet for detailed instructions and precautions during mounting and installation.)

## TILTIX INCLINOMETER WITH ANALOG & RS232 INTERFACE

### 2.4 Measurement Axes

#### 2.4.1 ACS-080 – Dual Axis Inclinator

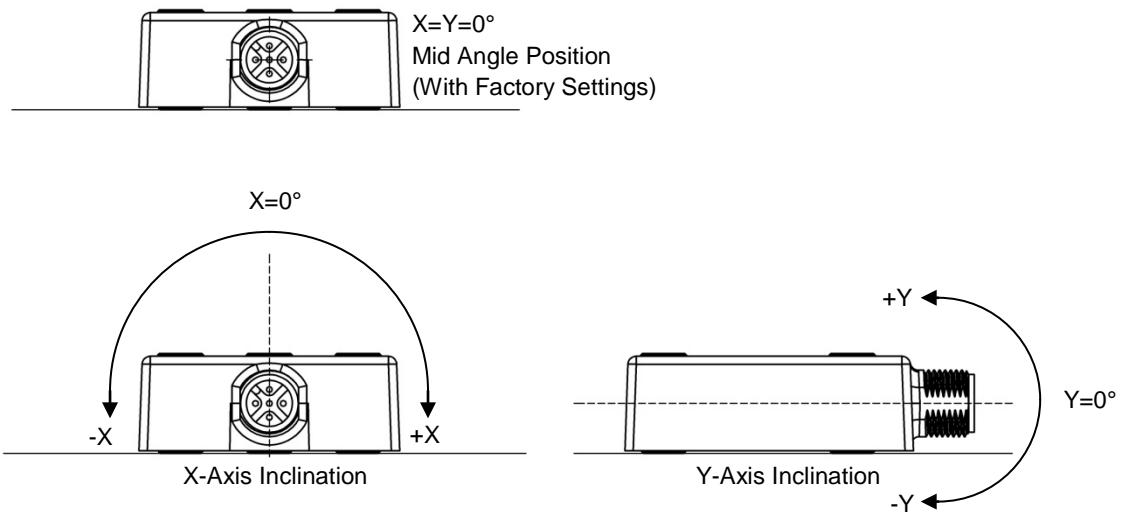

#### 2.4.2 ACS-360 – Single Axis Inclinator

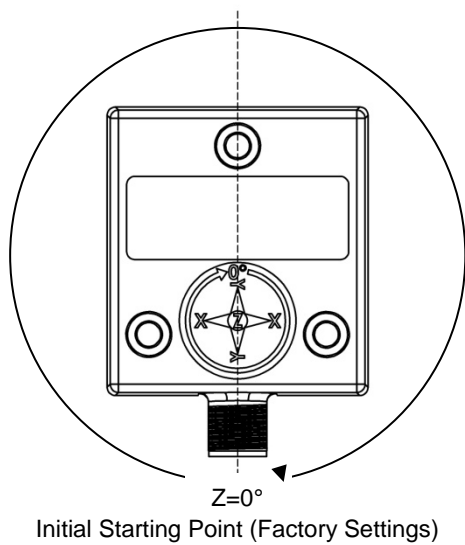

### TILTIX INCLINOMETER WITH ANALOG & RS232 INTERFACE

## 3. ACS-Analog Software Configuration

### 3.1 Default Factory Settings

Description	Value
Resolution	0.01°
Output Transmission Rate	100 ms
Baud Rate	9600 bps
Moving Average Filter	64
Angle Offset	0
Measurement Direction	ACS360: Clockwise ACS80: Standard
Configuration Mode	Preset/ Direction Mode

Note: The factory settings should be noted carefully upon installation. Few of the parameters have to be re-programmed in order to make the ACS inclinometers compatible with the measurement device, or optimize the measurement.

### 3.2 Modes of Operation

#### Measurement Mode

Measurement mode of an ACS is the free running operational output mode, in which the position value is sent cyclically (according to the output transmission rate) using the RS232 interface.

#### Configuration Mode

This mode is primarily used for modifying configurations and the settings of ACS using RS232 interface. In this mode, the position value is transmitted only upon request and is active until a power cycle, software reset or the ACS is switched to measurement mode. All settings saved in this level are stored in the EEPROM and permanently available also after power cycle.

There are two additional configurations for the teach-in functionalities which can be configured in this mode:

- Preset / Direction Mode  
This is the default mode. When in this mode, we can use an analog input for setting to zero position. The default direction setting is clockwise. Analog input for inverting direction is not available until setup to do so in RS232.
- Teach-In Mode (Scaling)  
This is used for scaling of the analog output over a desired range, using RS232 or Analog inputs.



### TILTIX INCLINOMETER WITH ANALOG & RS232 INTERFACE

#### 3.3 Programmable Parameters

The parameters/ settings of ACS can be re-configured using the RS232 interface. Additionally few of these functionalities are also available through Analog inputs SET1 and SET2.

		Adjustable via
Configuration Modes	ACS can be switched between Preset/Direction Mode and Teach-In Mode	RS232
Baud Rate	The Baud rate can be programmed to lie between ranges of 2400 bps and 115200 bps	RS232
Output Transmission Rate	The transmission rate of angular values can be adjusted to lie between 62.5 ms and 10 seconds per value	RS232
Moving Average Filter	Used to calculate the output position value as an average over last N values where N varies from 1 to 256 measurements (where $N = 2n$ , $n = 0, 1, 2, 3 \dots$ )	RS232
Preset Value	The current position value is set to the mid angle (2 Axes) and Zero position (1 Axis) by the parameter preset.	RS232 and Analog input <sup>1</sup> SET1
Measurement Direction	The direction of measurement can be inversed according to the measurement requirement	RS232 and Analog input <sup>1</sup> SET2
Analog Output Scaling	The analog output (4-20 mA / 0.5-4.5 V) can be scaled to the required measurement range The default ranges are 0° to 359.99° (1 Axis) and -80° to +80° (2 Axes)	RS232 and Analog inputs <sup>2</sup> SET1

1) Only in Preset/Direction mode

2) Only in Teach-In mode

### TILTIX INCLINOMETER WITH ANALOG & RS232 INTERFACE

#### 4. RS232 Digital Interface – Setup and Programming

The RS232 Digital interface of ACS gives flexibility by providing easily accessible positional values and a simple interface for setup and configuration using a PC or a laptop.

##### 4.1 Hardware Setup

###### 4.1.1 Accessories Required

- ACS Inclinator
- PC or Laptop with RS232 Interface
- 8-Wire open ended connection cable with M12 8-pin female connector
- D-Sub9 Female Connector

###### 4.1.2 Wiring & Connection

M12	Power Supply Unit	D-Sub9 Connector (PC)
3 (TxD)		2 (RxD)
2 (RxD)		3 (TxD)
4 (Ground)	Ground	5 (GND)
1 (VS)	Vs	

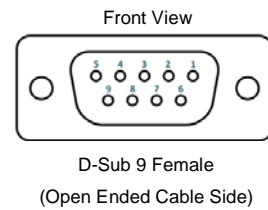

###### 4.1.3 Connection Setup

ACS Analog → M12 Connector → RS232 Connector → PC RS232 Port

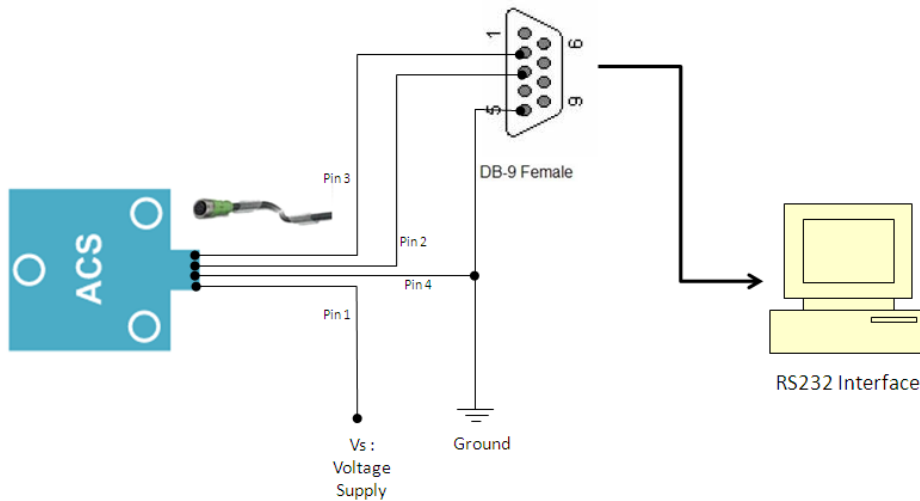

## TILTIX INCLINOMETER WITH ANALOG & RS232 INTERFACE

### 4.2 Software Communication Setup

Once the hardware is connected, the RS232 interface communication has to be setup using HyperTerminal or any other terminal programming client software. Communication with the sensor is done through a standardized RS232 interface. Data transmission is effected in duplex mode. Interface Parameters:

- Baud Rate: 9600 bps
- Data Bits: 8 Bits
- Parity: Even Parity
- Stop Bits: 1 Bit
- Flow Control: None

**Step 1:** Open the executable file of PuTTY-A Telnet/SSH client freeware. Please click on Serial Connection type and then type in the appropriate COM port in the Serial line column and the current Baud rate in the Speed dialog box. Then select, SSH → Serial to setup the parameters for interface communication.

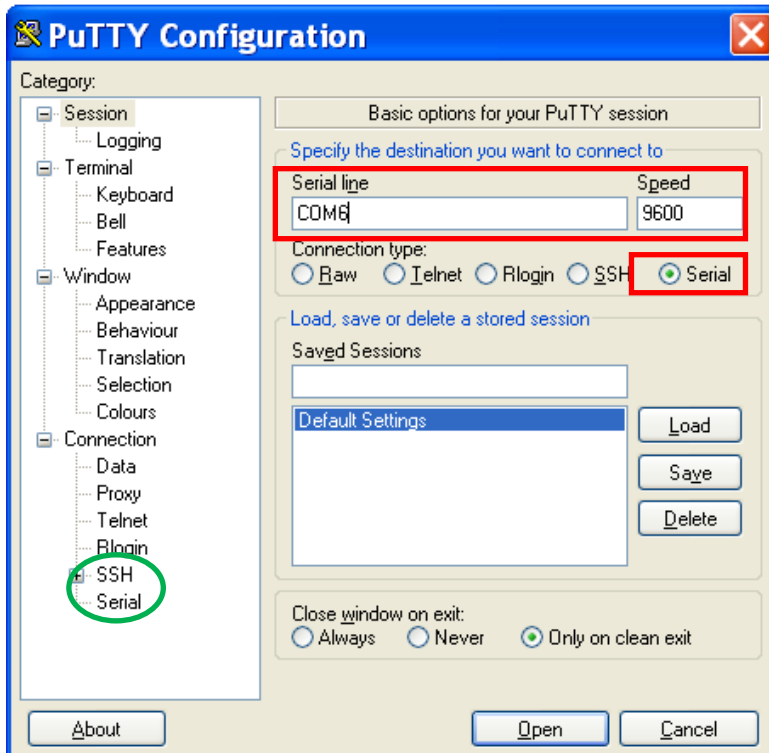

### TILTIX INCLINOMETER WITH ANALOG & RS232 INTERFACE

**Step 2:** Select the appropriate parameters for the RS232 interface communication and please click on Open to create a new terminal program for ACS RS232 interface communication.

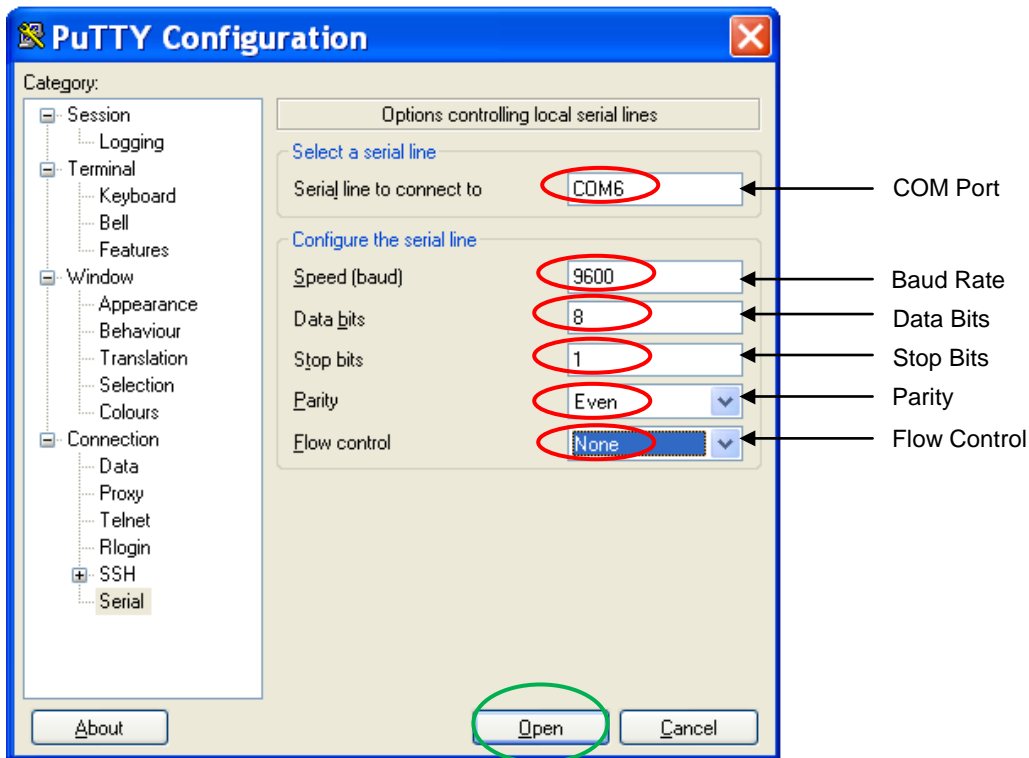

Power off – Power On for getting a boot-up message on startup.

New Terminal Program: (Factory setting in measurement mode. Hence, continuous angular values)



Boot-up Message Representation

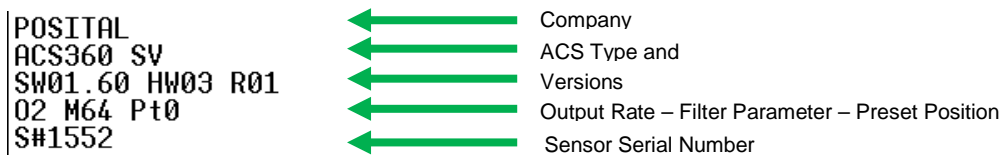

Boot up message may vary with different versions but the important parameters will always be included.

### TILTIX INCLINOMETER WITH ANALOG & RS232 INTERFACE

**4.3 Table 1: Commands in Configuration Mode**

General Instructions	To the Sensor
Enter configuration mode	"Enter"
Leave configuration mode	exit<CR>
List all commands and their	help<CR>
Software Reset <sup>1</sup>	*rst<CR>
Report the identity and versions	*idn<CR>
Parameter Info	info<CR>
Set output rate <sup>2</sup>	period<CR>
Read current position value	read<CR>
Set new baud rate <sup>3</sup>	baud<SP>parameter<CR>
Set new moving average filter value <sup>4</sup>	filter<SP>parameter<CR>
Restore factory settings (requires	restore<CR>
Save settings to EEPROM <sup>5</sup>	save<CR>
Mode configuration <sup>6</sup>	teach<SP>0<CR> → <i>Preset / Direction Mode</i> teach<SP>1<CR> → <i>Teach-in Mode</i>
Set origin at current position (Preset) <sup>7</sup>	setorg <sup>7</sup> <CR>
Reset the origin to factory default position	clorg<CR>

#### Teach-in Mode Commands

Set maximum V/I at current position	setmax<CR>
Reset the maximum V/I to factory default position	clrmax<CR>

#### Preset/Direction Mode Commands

Invert the direction of measurement | compl<SP>parameter<CR>

- 1) After reset, the ACS reboots in the measurement mode giving a startup/ boot-up message.
- 2) See Table 2 for defined code transmission rates
- 3) See Table 3 for defined baud rates. . A reset of the baud rate to the default value is not possible.
- 4) The Moving Average Filter length accepts only 2n values. E.g. 4, 8, 16, 32.. etc. and the max. length is 256. If the input number isn't a 2n number, the next lower 2n number will be taken.  
E.g. input = 14 will be rounded to 8, Input =18 will be rounded to 16, etc...
- 5) In case of changing the baud rate, the new baud rate will be active direct after a <CR>, a "save" command is not required.
- 6) Only sensors with version 1.86 software will have teach-in functionality. Refer to bootup message for version
- 7) setorg is used for both setting the preset and scaling in both teach-in and Preset/direction modes

### TILTIX INCLINOMETER WITH ANALOG & RS232 INTERFACE

**Attention:**

- A reset of the baud rate to a default value is not possible. If the user forgets the adjusted baud rate, the new value must be detected by testing only.
  - Generally a Space should separate a command and a parameter. Examples:  
period 2  
baud 3
- Typing a command with a question mark (?) at the end (without Space) will return the current setting.  
Examples:  
ACS>period?  
Period 2: 100 ms  
OK  
ACS>baud?  
Baudrate 2: 9600  
OK

**4.3.4 Table 2: Code Transmission Rates**

Input Character to Sensor	Output Transmission Rate (ms)
1	62.5
2	100 <sup>1</sup>
3	200
4	500
5	1000
6	5000
7	10000

1) Default Factory settings

**4.3.4 Table 3: Baud Rates**

Input Character to Sensor	Baud Rate (bps)
0	2400
1	4800
2	9600 <sup>1</sup>
3	19200
4	38400
5	57600
6	115200

1) Default Factory settings

### TILTIX INCLINOMETER WITH ANALOG & RS232 INTERFACE

#### 4.3.5 Preset/Direction and Teach-in Mode

- **Preset/ Direction Mode (teach 0)**

The Preset/Direction mode is the default mode in which the ACS operates. In this mode the user can set the origin of measurement (0° Reference Angle) at the current point and can also change the direction of measurement. The changes done in the RS232 mode also get reflected in the analog output.

- **Preset: Set Origin at current Position (setorg)**

The “setorg” command is used to set the origin (0° reference) to the current position. The analog output is also reset to read either 4 mA or 0.5 V according to the analog interface in use.

- **Reset the origin to factory default (clorg)**

The origin position can be reset to factory default position by using this command. The analog output is also reset to show the factory default output.

- **Invert the direction of measurement (compl)**

The “compl” function is used to specify the direction of measurement to either Standard or Inverted according to the user’s requirement. The default setting is clockwise (ACS360). The analog input SET2 can be used for this function only if compl is set to “2”.

Compl. Configuration – RS232	SET2 Analog Input <sup>1</sup>	Counting direction of ACS
0 – Clockwise only	L	No Change with Analog Input
	H	
1 – Counter clockwise only	L	No Change with Analog Input
	H	
2 – SET 2 Activate	L	Clockwise / Standard
	H	Counter clockwise / Inverted

1) For detailed explanation on analog teach, please refer next section.

### TILTIX INCLINOMETER WITH ANALOG & RS232 INTERFACE

- **Teach-In mode (teach 1)**

This is the mode used for scaling the ACS output as per the users' requirement. The user can set the range of measurement and the ACS analog output is scaled accordingly. The range of measurement is defined to lie within the origin and maximum angle positions, which then corresponds to the analog output scaling.

Note: The maximum angle set in this mode will not affect the RS232 position output. This scaling only affects the analog output.

The execution of this "setmax" is immediately reflected in the analog output. The analog output at the set-point is either 20 mA (Current) or 4.5 V (Voltage) once the execution is complete.

The execution of "clrmax" function clears the previous scaling done by the user and resets the analog output to the factory default values.

**Important Points for programming:**

- The use of preset in the digital interface will affect the analog output too. When using both the interfaces simultaneously take appropriate pre-cautions.
- Be careful not to mix up the commands for the RS232 teach-in modes. If in doubt, use the restore command and reconfigure sensor
- The configurations/ scaling set in teach 1 mode is not reflected in teach 0 mode
- Errors

When parameters are defined beyond the programmable limits then the ACS gives an error "E" output. We know that the code.



### TILTIX INCLINOMETER WITH ANALOG & RS232 INTERFACE

## 5. Analog Interface

### 5.1 Output Types

#### 5.1.1 ACS – Voltage

Connect the corresponding (voltage – analog output Pin 5 and/or 7) open end of the connection cable to the measurement system. It is the same setup for both ACS360 and ACS80. Please be careful of the output cable you select.

General Specifications:

- Supply voltage range: 5 V – 30 V
- Current consumptions (no load): 70 mA @ 5 V, 30 mA @ 10 V and 20 mA @ 24 V
- Analog interface: 0,5 V – 4,5 V, 1 mA (Max.)
- Output is linear
- Capacitive loads (allowed range): 1 nF – 100 uF
- Resistive Loads: > 5 kΩ
- Digital interface: RS232 with ASCII format, Max. Baud rate: 115200 bps

#### 5.1.2 ACS – Current

Connect the corresponding (current – analog output Pin 5 and/or 7) open end of the connection cable to the measurement system. In ACS current,  $I_{out}$  can be directly measured or indirectly measured as voltage, using a shunt resistor (Note:  $R_{Load} \leq 500 \Omega$ ). It is the same setup for both ACS360 and ACS80. Please be careful of the output cable you select.

General Specifications:

- Supply voltage: 16 V – 30 V
- Current consumptions (no load): 30mA @ 16V and 20mA @ 24V
- Analog interface: 4 mA – 20 mA
- Output is linear
- Max.  $R_L = 500 \Omega$
- Digital interface: RS232 with ASCII format, Max. Baud rate: 115200 bps

### TILTIX INCLINOMETER WITH ANALOG & RS232 INTERFACE

#### 5.3 Analog Inputs (SET1 and SET2)

The inclination sensors are designed to include 3 features through analog inputs SET1 and SET2.

- Preset of origin - 0° Reference for measurement
- Inversion of measurement direction
- Output scaling according to the set measurement range

The ACS has two configuration modes for the above functionalities:

- Preset/Direction mode: Configuration for setting the new origin and direction of measurement
- Teach-In Mode: Scaling of output according to user's measurement range.

The modes can be changed using the RS232 interface. By default, the ACS sensor is in the Preset/Direction Mode, with the option of inverting direction with an analog input only if configured to do so in RS232.

The ACS has two analog inputs, SET1 and SET2 which can be used to configure in the ACS. To trigger/activate these functionalities (e.g. a Preset):

- The user must apply a positive voltage (5 V – 30 V,  $R_{in} > 110\text{ K}\Omega$ ) on the SET1/SET2 input. When a high edge is recognized a timer starts.
- The voltage must be held at least 100 ms. If the voltage has been held less than 100 ms, the timer will be reset. The voltage must be released for position to be locked.

#### 5.3.1 Preset

The ACS has to be set to the Preset/Direction mode (teach 0) through the RS232 interface to implement this function. Preset/Direction mode is the default factory setting.

To set the preset, apply a high signal (5 V – 30 V) pulse to SET1 input and lock the position. Once the position is locked the ACS resets the current position to the origin position and hence changes the analog output accordingly to either 4 mA or 0.5 V.

Note:

- The origin set by the analog input SET1 can be revoked to the factory default setting by using clorg function in the RS232 interface.
- The Preset function in ACS080 is applied to both axes at the same time. There is no separate Preset function for each axis.

### TILTIX INCLINOMETER WITH ANALOG & RS232 INTERFACE

#### 5.3.2 Invert Direction

The ACS has to first be set to the Preset/Direction mode (teach 0) and the “compl” function has to be set to parameter 2 (compl 2) through the RS232 interface to implement this function.

SET2	Direction of Measurement
High (5 V-30 V)	Counter-Clockwise / Inverted
Low (No Connection) or GND	Clockwise / Standard

To set the inversion of direction, apply a continuous high signal (5 V -30 V) to SET2 input. As long as the applied signal on SET2 is greater than 5 V, the direction of measurement is always inverted.

#### 5.3.3 Scaling of Output

The ACS has to first be set to the Teach-In mode (teach 1) through the RS232 interface to implement this function. Scaling of output is done based on a user defined angular measurement range. The range is defined by the two set points created by analog teach-in inputs SET1 and SET2. The analog output is scaled to give a full measurement output (4 – 20 mA / 0.5 – 4.5 V) over the defined range of measurement.

It is recommended to do scaling as a sequence of steps as detailed below:

- Set the ACS to Teach-In Mode (teach 1)
- Give high signal pulse to SET1 at the origin of the measurement range to lock the position. Once position is locked (indicated by origin position output (4 mA or 0.5 V)) move to next step.
- Give high signal pulse to SET 2 at the end of the measurement range. Once position is locked (indicated by end position output (20 mA or 4.5 V)) the scaling is complete.

If the scaling was done correctly the ACS should give a (4 mA – 20 mA) or (0.5 V – 4.5 V) output in the range of measurement set between the locked positions of SET1 and SET2.

- The scaling can be done also counter-clockwise. The output is scaled according to the direction of the sensor motion for the SET inputs. Upon scaling, the RS232 angular output sets preset automatically at SET1 position

### TILTIX INCLINOMETER WITH ANALOG & RS232 INTERFACE

#### Appendix A: Ordering Code

Description	Type key									
	ACS-	XXX-	X-	XX	XX-	X	X	X-	XX	
Range	360° (1 axis)	360								
	± 80° (2 axis)	080								
Number of axis	One for 360° Version		1							
	Two for ± 80° Version		2							
Interface	Voltage + RS232			SV						
	Current + RS232			SC						
Version	Software Version				00					
Mounting	Vertical for 360° Version					V				
	Horizontal for ± 80° Version					H				
Housing Material	Industrial (PBT)						E			
	Heavy-Duty (Aluminium)						H			
Inclinometer Series	ACS II							2		
Connection	Connector									PM

Note: SSI, DeviceNet, and CANopen options are also available. Please see our website for details.

#### ACS Analog Type-Keys

##### ACS Voltage

ACS-360-1-SV00-VE2-PM  
 ACS-080-2-SV00-HE2-PM  
 ACS-360-1-SV00-VH2-PM  
 ACS-080-2-SV00-HH2-PM

##### ACS Current

ACS-360-1-SC00-VE2-PM  
 ACS-080-2-SC00-HE2-PM  
 ACS-360-1-SC00-VH2-PM  
 ACS-080-2-SC00-HH2-PM

### TILTIX INCLINOMETER WITH ANALOG & RS232 INTERFACE

#### Appendix B: ACS Output Data Frame

##### ACS080

The following table is for the character and its corresponding decimal/ hexadecimal equivalents to assist a user in the output programming.

Byte Order	D0	D1	D2	D3	D4	D5	D6	D7	D8
ASCII	X	=	±	x	x	.	x	x	;
Decimal	88	61	(+:43) (-:45)	2 Bytes Angle Information		46	2 Bytes Angle Information		59
Hexadecimal	0x58	0x3d	(+:0x2b) (-:0x2d)			0x2e			0x3b

Byte Order	D9	D10	D11	D12	D13	D14	D15	D16	D17	D18
ASCII	Y	=	±	x	x	.	x	x	CR <sup>1</sup>	LF <sup>2</sup>
Decimal	89	61	(+:43) (-:45)	2 Bytes Angle Information		46	2 Bytes Angle Information		13	10
Hexadecimal	0x59	0x2d	(+:0x2b)			0x2e			0x0d	0x0a

1) Carriage Return

2) Line Feed

ACS80 Output Display : <D0.....D18>

Byte count (total): 19 Bytes

##### ACS360

The following table is of the character and its corresponding decimal/ hexadecimal equivalents to assist a user in the output programming.

Byte Order	D0	D1	D2	D3	D4	D5	D6	D7
ASCII	x	x	x	.	x	x	CR <sup>1</sup>	LF <sup>2</sup>
Decimal	3 Bytes Angle Information			46	2 Bytes Angle Information		13	10
Hexadecimal				0x2e			0x0d	0x0a

1) Carriage Return

2) Line Feed

ACS360 Output Display: <D0.....D7>

Byte count: 8 Bytes

#### Document History

1st Release: Anjan Nachiappa on September 28<sup>th</sup>, 2011 (20110928)

2nd Release: Anjan Nachiappa on February 1<sup>st</sup>, 2012 ( 20120201/ > V1.86)

3rd Release: Thomas Motto on February 21, 2012 (20120221/ > V1.86)

TILTIX INCLINOMETER  
WITH ANALOG & RS232 INTERFACE

**Disclaimer**

© FRABA N.V. all rights reserved. We do not assume responsibility for technical inaccuracies or omissions. Specifications are subject to change without notice.